



05/12/23 16:10:49
BEST BY: 11/12/25

05/12/23 16:10:49
BEST BY: 11/12/25

Laser Marking System

Videojet 3350 CO₂ Laser Series

Designed for seamless automated product changeovers



A connected solution for seamless automation

Get the next-level flexibility you need to
adapt to rapidly changing production
environments with the Videojet 3350 series



Connect | Automate | Simplify

3350

With unparalleled digitally-enabled capabilities, this 30-watt CO₂ laser is the ultimate solution for marking complex and high-quality codes at lightning-fast speeds in various industries such as food, beverage, cosmetics, pharmaceutical, and extrusion. It allows for virtually unlimited font, code, and graphic options and boasts impressive line speeds of up to 900 m/min.

3350 Smart Focus

This advanced model not only offers all the features of the 3350 but also caters to the growing demand for automation and flexibility. Equipped with cutting-edge automatic and dynamic marking capabilities, it allows for seamless product changeovers without any manual intervention, thereby supporting your journey towards Industry 4.0.



Improve your uptime while delivering unmatched print quality

The 3350 series benefits

- High-speed marking capability prints up to 2,000 characters per second of text, bar codes, graphics, and other information
- High-resolution marking head delivers high-quality and permanent codes to support product traceability and anti-counterfeiting
- Variety of lenses deliver one of the largest marking areas while options like beam turning unit options simplify integration
- Multiple marking heads and wavelengths provide the flexibility to code a wide range of materials such as plastics, wood, glass, ceramics, and coated metals
- Up to 45,000 hours of laser source life expectancy offers extended operational life, reliable performance, and reduced cost of ownership
- Air-cooled laser source helps reduce maintenance intervals and additional costs
- Wi-Fi and cellular* connectivity capabilities offer advanced remote services to improve printer availability and OEE

**Subject to availability in your country*

Multi-level surface marking

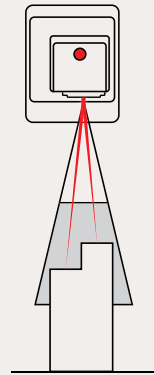

Mark different-sized products in the same marking field with 2.5D technology. You can save time and more easily manage complex marking.

Precise and permanent marking on a broad range of product and packaging materials



Beverage – plastic



Beverage – glass



Personal care – plastic

The Smart Focus feature helps you reduce manual intervention and get you one step closer to an automated production line

Auto-adjustable focal distance

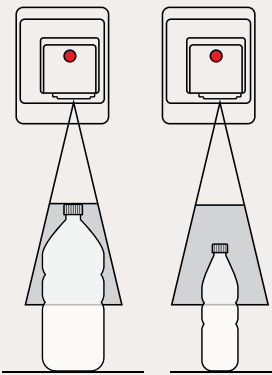

Automatically adjust the focal distance after initial job setup without moving the laser system up and down, reducing errors and user intervention.

Uniform flat field correction



Maintain exceptional print quality with a uniform spot-size marking across the entire field, with no degradation at the edge.

Pilot beam focus finder

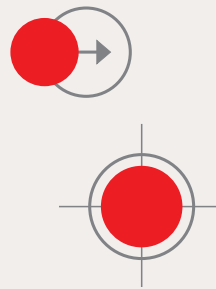

Validate if your laser is focused and positioned correctly, so you can speed up your setup time. Right working distance and right alignment.

Flexible range and size mode

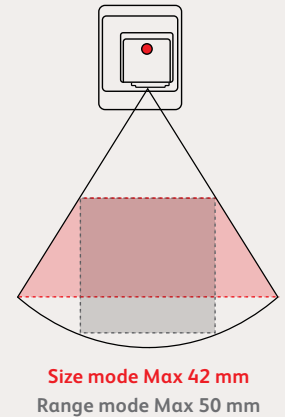

Effortlessly alternate between greater focal distance range or an expanded marking field size, allowing for the completion of a diverse array of jobs.



Extrusion – PVC



Food – Paper label



Pharmaceutical - paper board

Pathway to productivity

Benefit from Videojet Born Digital solutions that help minimize IT cost and workload, improve printer availability, and boost overall equipment efficiency

The easy and secure way to wirelessly communicate, manage automatic software updates, and reduce installation time by up to 33%

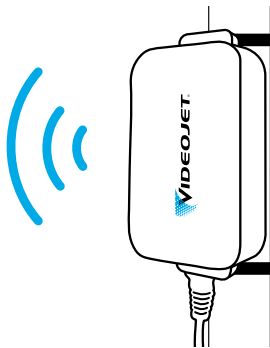

Wi-Fi and cellular communication

Wi-Fi and cellular* connections, which are in an access box, satisfy IT standards and offer seamless software updates and fewer service interactions while improving overall equipment efficiency with access to more information.

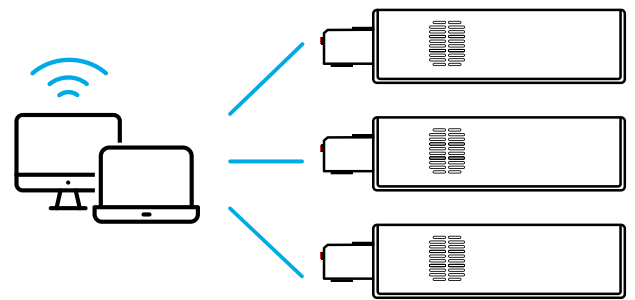

Remote interface control

Webserver capability allows customers to access printers via supported web browsers on host computers. Up to five web server sessions are allowed for each printer.

On-demand remote technical support and advanced troubleshooting to anticipate potential printer issues in time and enable fast recovery



First-to-know

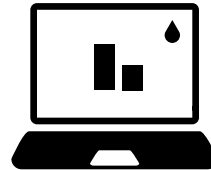

First-to-react

Real-time remote visibility

VideojetConnect™ Remote Service* provides real-time information on printer issues, allowing both Videojet experts and your technicians to monitor equipment status, troubleshoot issues, and improve long-term performance.

**Subject to availability in your country*

Simplified usability

Speed up equipment set-up and enjoy seamless integration into your line with easy beam positioning exactly where you need it

- Intuitive web-based user interface combined with a range of laser controller units, allows for simple operation and message creation and helps to ensure seamless production
- Detachable umbilical cable for faster setup, easy redeployment, and simple-to-use accessories connections
- Flexible marking head, including 32 standard beam delivery options (3350) or 0° to 90° rotation without the need for additional parts (3350 *Smart Focus*)
- Operator interface options and a choice of networking communications to match your preferred workflow

Technology to help meet your sustainability objectives

The Videojet laser portfolio delivers the flexibility to stay ahead of constantly evolving sustainability regulations and the resultant marking needs.

As the packaging industry moves towards the use of more sustainable materials, our **broad portfolio** of **CO₂, fiber, and UV laser technologies** – combined with our **deep expertise** and unique integration solutions – can help you meet developing requirements.

Our proprietary galvo control gives operators a speed advantage, either

marking more products with a single laser or minimizing the time the laser is in use, **reducing energy consumption** in both cases.

Videojet laser printers are also **virtually maintenance-free**, which helps maximize your machine's availability, delivering the highest OEE and lowest waste coding alternative.



Videojet 3350 Series Laser Marking System

Model name	3350	3350 Smart Focus
Laser power	30W	
Laser tube	Sealed CO ₂ laser	
Wavelengths	9.3µm, 10.2µm and 10.6µm	
Sealing	Marking Unit and Supply Unit: IP54, optional IP65	
Marking speed	Up to 2,000 characters/sec ⁽¹⁾	
Line Speed	Up to 15m/sec (49ft/sec)	
Beam exit options	90° and straight-out	
Marking heads	SHC-60, SHC-100, SHC-150	SHC-SF
Focusing method	Focusing lens	Dynamic telescope
Marking field	Min. 30.8 x 38.2 mm ² Max. 601.0 x 439.8 mm ²	Min. 52.72 x 129.35 mm ² Max. 70.79 x 178.42 mm ²
Focal lengths	64/ 95/ 127/ 190/ 254 mm (2.5/ 3.75/ 5.0/ 7.5/ 10.0 inches) 63.5/ 85/ 100/ 150/ 200/ 300/ 351/ 400 mm (2.50/ 3.35/ 3.94 / 5.9/ 7.87/ 11.8/ 13.8/ 15.75 inches) 400/ 500/ 600 mm (15.75/ 19.68/ 23.62 inches)	94 - 144 mm (3.7 to 5.6 inches)
Adjustable focal distancing	Not available	√
Multi-level marking	Not available	√
Flat field correction	Not available	√
Pilot laser integrated	Optional	√
Pilot beam Focus finder	Not available	√
Flexible Range-Size mode	Not available	√
Dynamic product change-over	Not available	√
Rotate head in 90° raster	√	√
BTU (32 rotations)	√	Not available
Connectivity - Cellular	Standard*	Standard*
Connectivity - Wi-Fi	Standard*	Standard*
Operator interface options	TCS+ Touch control software / CLARiTY™ control software / Smart Graph	
Marking format	<ul style="list-style-type: none"> - Standard industrial fonts (Type 1 Windows® TrueType®) and Single line fonts Machine-readable codes (OCR, 2D-matrix, etc.) - Bar codes: BC25, BC251, BC39, BC128, GS1-128, EAN13, UPC_A, RSS14, RSS14 Truncated, RSS14 Stacked, RSS14 Stacked Omnidirectional, RSS Limited, RSS Expanded, etc. - 2D codes: DataMatrix, DMRE, GS1, QR - Graphics, logos, symbols, etc. - Linear, circular, angular, reverse, rotate - Sequential and batch numbering - Automatic date, layer, and time coding; real-time clock - Dot mode enables marking 2D codes faster than traditional grid mode 	
Languages	Support for 30 languages Additional languages available with Smart Graph software	

* Subject to availability in your country

⁽¹⁾ Maximum marking and line speed is application dependent

Call **+254-20-3893800**
Email **marketing.kenya@videojet.com**
or visit **www.videojet.co.ke**

Videojet Technologies
Keystone Park, Block A,
5 Riverside Drive, Westlands,
Nairobi, Kenya.



© 2023 Videojet Technologies Inc. — All rights reserved.
Videojet Technologies Inc.'s policy is one of continued product improvement. We reserve the right to alter design and/or specifications without notice.

Part No. SL000721
br-3350-en-ke-0623

